

0.11



卫生卡箍由任 Sanitary Clamp Union series

国家高新技术企业 浙江省著名商标
www.cndonjoy.com



东正一直致力于技术进步，是您值得信赖的事业伙伴！
Donjoy committing to major technological advances, is your reliable business partner!

0.1	自控调节阀+控制器 Automatic control regulating valve +Control head
0.2	生物制药隔膜阀 Biopharmaceutical diaphragm valve
0.3	高洁净泵 High purity pumps
0.4	防混蝶阀+蝶阀 Mixing proof butterfly valve +Butterfly valve
0.5	球阀 Ball valve
0.6	截止换向阀+防混阀+罐底阀 Divert seat valve+Mixing proof valve +Tank bottom valve
0.7	角座阀+截止阀 Angle seat valve+Globe valve
0.8	止回阀+恒压阀+安全阀+减压阀 Check valve+constant pressure valve+safety valve +air release valve
0.9	清洁技术+取样阀+视镜+照明技术 Clean technology+sample valve+sight glass +lighting technology
0.10	过滤器+人孔 Filter+man hole cover(manway)
0.11	卫生管件 Sanitary fittings ASME BPE DIN11852 Bs4825 SMS ISO IDF 3A



注意：
目录技术资料仅供设计参考，
设计更新和技术升级恕不另行通知！

东正始终坚持以不断革新的技术、日新月异的市场发展和客户需求是当今我们面临的最大挑战。面对这些挑战我们信心十足，因为东正高度专业化的产品和技术创新，是我们未来将以更高、更优的产品来满足不断增长的市场需求。

Technological innovation, rapid development of the market and customer needs are the greatest challenges facing us today. Facing with these challenges we are confident, because of highly professional products and technological innovation, we will meet the growing demand of market and customer with our better and better products.

法律声明：
目录样册版本属东正所有，如有抄袭东正将追究其法律责任和经济赔偿。东正已获得国家版权局书刊号。
东正众多技术设计，都具有专利保护，如有抄袭，东正必将追究法律责任和经济赔偿。

领先源于创新 创新源于专业
东正的专业与品质的邂逅源于创新的精神



现代化工厂已经投产，期待您的光临！
温州空港经济园区生产基地
Wenzhou airport economic zone production base

占地面积29000m²，总投资1.2亿元，新引进工业机器人、5轴加工中心、机器人抛光设备。

Covering an area of 29000 m², with total investment after construction is expected to 120 million yuan, introduces new industrial robot, five axis machining center, machine Polishing equipment.

东正创立于1993年，注册资金5508万，是一家专注于研发高品质PID过程控制器、阀门定位器、流量控制器，阀门控制单元，高洁净过程控制阀、智能自控阀，高洁净泵、高洁净管材和管道配件。公司高度专业化的产品和技术专注于生物制药、食品饮料、酿酒、精细化工等工业领域。东正众多的创新解决方案，对满足全球，尤其是新兴市场不断增长生物制药和食品饮料行业的需求起到了积极作用。

东正制造的产品母材料、加工技术、焊接技术、表面处理等技术指标均已达到国内外先进水平。且符合ASME BPE、EHEDG、FDA、3A等一系列国际标准和规范要求，先后通过了由德国 TÜV机构实施的欧盟承压设备指令(PED-97/23/EC)和(MD-06/42/EC)认证、美国 3A机构实施的3-A卫生标准认证、中国安全阀特种制造设备(TS)许可证和中国质量认证中心CQC ISO9001:2008 质量管理体系认证等多项国际权威认证。

东正凭借先进的技术、优异的品质和完善的售后服务体系，先后被评定为国家高新技术企业，省著名商标、省科技型企业、创新型企业、专利示范企业、研发中心企业，守合同重信用AAA企业等众多荣誉。



关于东正 About DONJOY

Donjoy was built up in 1993, with registered capital RMB 55.08 millions. We focus on developing high quality PID process controller, the valve positioner, the flow controller, the valve control unit, high purity process control valve, intelligent self-control valve, high purity pump, high purity tubing fitting and pipeline accessories. Donjoy's products and technologies are widely used in biopharmaceutical, food, drink, wine fine chemicals and other industrial fields. Donjoy's innovation solutions meet the growing demand of the industry of biopharmaceutical, food and beverage from the whole world, especially the emerging market.

Raw material, processing technology, welding technology, surface treatment from Donjoy have achieved advanced levels of domestic and foreign market. Donjoy productions according to ASME BPE, EHEDG, FDA and 3A standard, get certificate of PED-97/23/EC and MD-06/42/EC issued by TUV, 3A issued by 3A organization, TS licence and ISO9001:2008.

Donjoy with advanced technology, excellent quality and perfect after-sales service system, has been assessed as the national high-tech enterprises, the Provincial Famous Trademark, the Provincial Science and Technology Enterprises, Innovative Enterprises, Patent Model Enterprises, R & D Center, AAA Credit Enterprises.



创立于2005年现代化工厂
温州滨海经济开发区生产基地
Wenzhou binhai economic development zone production base

DONJOY high-purity valve, pump, control system, pipe and accessories, provide the most excellent solution for various business scopes.

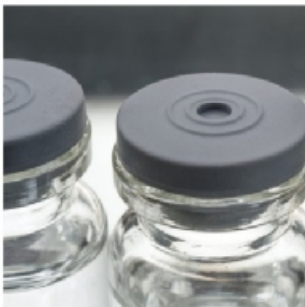

Biopharmaceutical



Dairy



Food

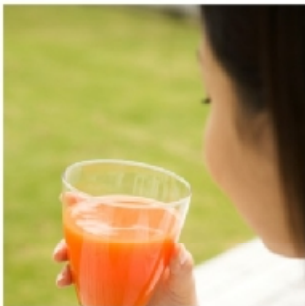

Beverage



Water Processing



Brewing



Fine Chemical

制造与检验 Manufacturing and testing



机器人生产线 Robot production line

全自动弯管设备 Automatic pipe bending equipment

DONJOY以科学技术是第一生产力，也是企业核心竞争力，只有不断投入核心技术研发和创新，不断追求卓越，精益求精、以先进生产设备，严格的质量管理体系，精密的生产检测流程，保证每一款产品优良的性能。

Science and technology constitute a primary productive force, also the core competitive strength of the enterprise. Continuously intensifying the research, development and innovation of core technology, pursuing prominence and keeping improving, ensuring the excellent quality and performance of every single product by advanced production equipment, strict quality control and precise production and inspection procedures.



至精 至洁 历久弥新

20多年的经验是您值得信赖的品牌-DONJOY

东正管件系列产品已全部通过美国-3A-63-03认证；橡胶垫圈FDA 177.2600，PTFE垫圈FDA177.1550。

材质：304、316L、1.4301、1.4404、1.4435 NB2 Fe<0.5%

表面处理：机抛光 DIN 11866 HE3c HE4c HE5c, ASME BPE SFF1 SFF2 SFF3

电抛光 DIN 11866 HE3c HE4c HE5c, ASME BPE SFF4 SFF5 SFF6



异形管件系列
(定制品)



卡箍式管件
Clamp pipe fittings



管件系列
DIN SMS ISO
BS4825 3A



无菌系列-
由任-法兰-卡箍由任
Aseptic series-Union-
Flange-Clamp union

BPE管件
BPE pipe fitting



由任
Union



管支架
Pipe holder



I-Line管件系列
I-line fittings



斜座式密封3A由任
Bevel seal ferrules



卫生钢管
Tube



材质和连接标准

Material and connectivity standards

材质有多种选项

- ◆ 1.4435-BN2 (316L) Fe < 0.5% Forged
- ◆ ASME BPE 316L
- ◆ ASTM 304, 1.4301
- ◆ ASTM 316L 1.4404

不锈钢化学成分规范
Chemical composition for automatic weld ends, %

根据ASDME BPE Table DT-3		EN 10088-3 1.4435 NB2 Fe≤0.5%	
Carbon, max	0.035	Carbon, max	< 0.03
chromium	16.00-18.00	chromium	16.00-18.00
manganese, max	2.00	manganese, max	2.00
molybdenum	2.00-3.00	molybdenum	2.5-3.0
nickel	10.00-15.00	nickel	12.5-14.0
phosphorus, max	0.045	phosphorus, max	0.045
silicon, max	1.00	silicon, max	1.00
sulfur	0.005-0.017	sulfur	≤ 0.030
		nitrogen	< 0.11

管道接口标准 Pipeline end standard

下表格：以DN25为列的不同国际标准卫生级不锈钢管道直径的区别

Next form: Take DN25 for example to illustrate the stainless steel pipe OD difference in different International standard health grade

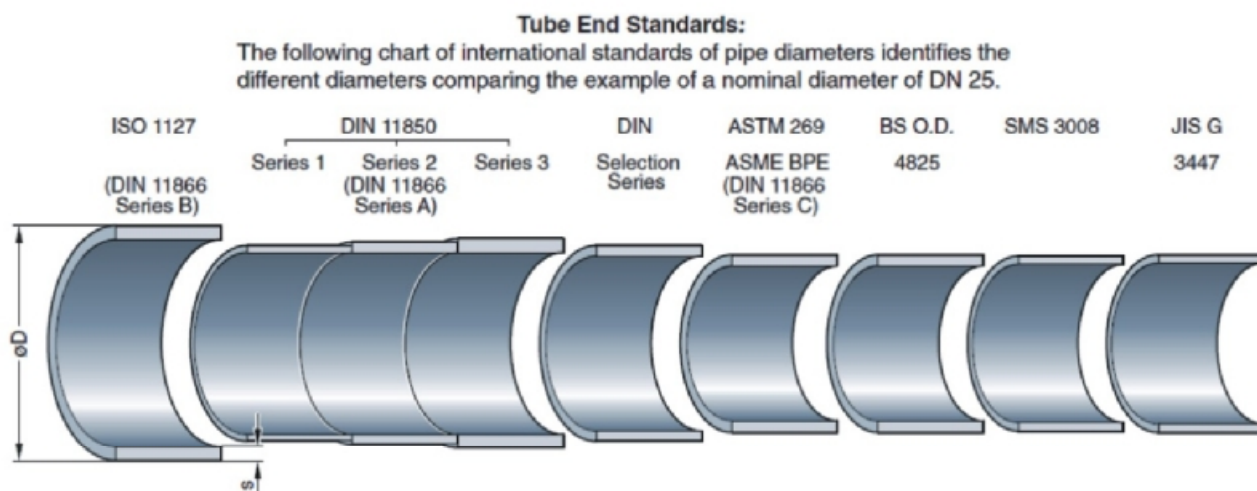

表面处理

Surface treatment

表面处理 Surface treatment

对高洁净的工艺管路系统来说，表面的粗糙度是极其重要的技术指标
For high clean process piping system, the roughness of the surface is an extremely important technique index



Surface finish: machined,
Ra 1.2 μm



Surface finish: machined,
Ra 0.8 μm



Surface finish: fine-machined,
and grinded, Ra 0.4 μm



Surface finish: fine-machined,
and grinded, Ra 0.2 μm



表面抛光 Surface polishing

Ra=粗糙度
平均粗糙度Ra值被作为衡量一个内表面光洁度的一个参数。
LT5.6mm 长度/测量Lc0.8mm进行5次测量粗糙度得出的平均值粗糙度Ra值。
根据ASME BPE和DIN 11866。

Ra = roughness
Average roughness Ra data is used as a measure of valve body surface finish of a parameter.
LT5.6 mm length/measurement Lc0.8 mm for five measuring roughness obtained average roughness Ra data.
According ASME BPE table to classified

Definition of the codes for Ra-Values Allocation to the standard DIN 11866

Ra μm	DIN 11866	α
	Hygiene class	E-polished
0.8		
0.8	HE3c	●
0.6		
0.6		●
0.4		
0.4	HE4c	●
0.25		
0.25	HE5c	●

Table SF-2.4-1 R_a Readings for Metallic Product Contact Surfaces

Surface Designation	Mechanically Polished [Note (1)]	
	R _a Max.	
	$\mu\text{in.}$	μm
SF0	No finish requirement	No finish requirement
SF1	20	0.51
SF2	25	0.64
SF3	30	0.76
	Mechanically Polished [Note (1)] and electropolished	
	R _a Max.	
	$\mu\text{in.}$	μm
SF4	15	0.38
SF5	20	0.51
SF6	25	0.64

卡箍系列 Clamp series

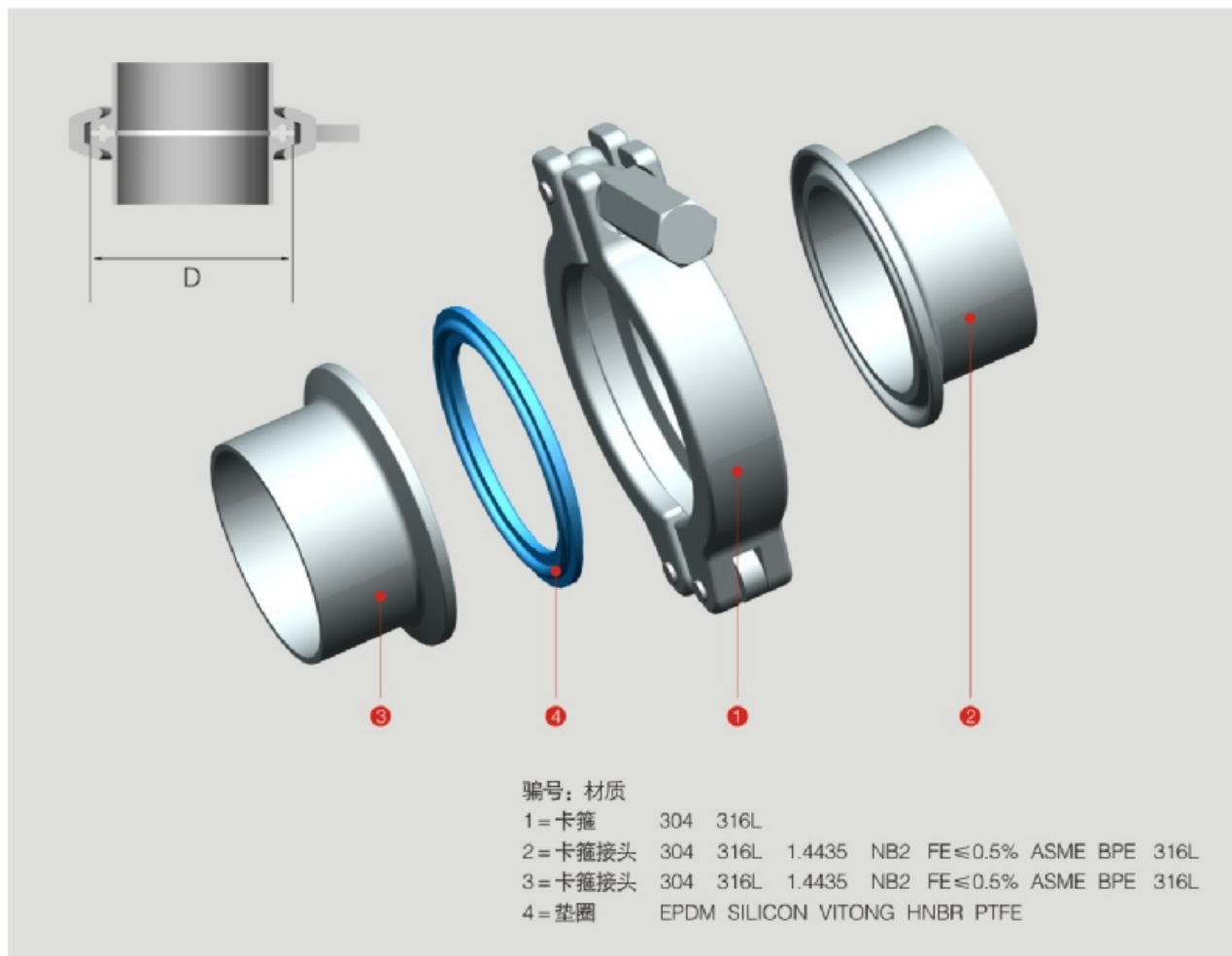

各种卡箍螺母 All kinds of clamp nut

适用于所有的卡箍 Suitable for all clamps

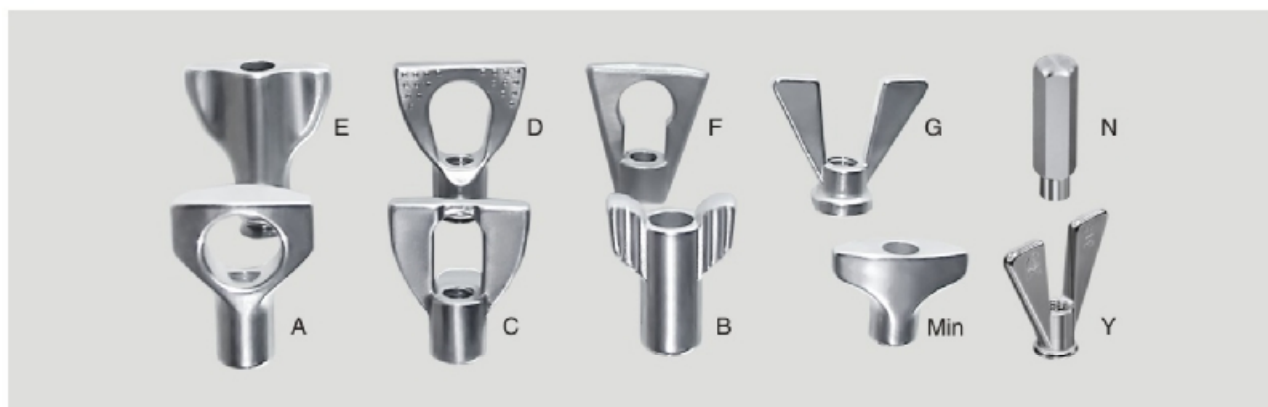

MINI -单销卡箍-(推荐型)
MINI/Single Pin Clamp(Recommended)

适用于Suitable for: 3A/ISO/IDF/BS/BPE/AS/DIN

代码 Cargo code : F040241

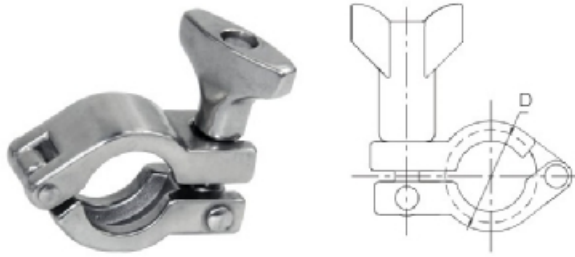

SIZE		卡盘	304 单重(g)
1/2-3/4"	DN10-20	25.2	130
1/2-3/4"	DN10-20	34	135

单销卡箍-A型(推荐型)
Single Pin Clamp/A Type(Recommended)

适用于Suitable for: 3A/ISO/IDF/BS/BPE/AS/DIN

代码 Cargo code : F040242



SIZE		卡盘	中型(g)-304 单重(g)	
1'-1.5'	DN25-40	50.5	195	
2"	DN50	64	225	
2.5"	-	77.5	270	
3"	DN65	91	308	
3.5"	DN80	106	360	
4"	DN100	119	410	
4.5"	-	130	505	

螺母可任意选择, 注意“E型”螺母需要加价。

单销卡箍-B型(选型) Single Pin Clamp/B Type(Option)

适用于Suitable for: 3A/ISO/IDF/BS/BPE/AS/DIN

代码 Cargo code : F040243



SIZE		卡盘	中型(g)-304 单重(g)	重型(g)-304 单重(g)
1'-1.5'	DN25-40	50.5	200.0	225
2"	DN50	64	245.0	270
2.5"	-	77.5	285.0	300
3"	DN65	91	290.0	318
3.5"	DN80	106	372.0	410
4"	DN100	119	385.0	445
4.5"	-	130		505
5"	DN125	145		805
5.5"	DN125	155		750
6"	DN150	166.7		870
6.5"	DN150	183		890
8"	DN200	217		1200
8.5"	-	240		1400
10"	DN250	268		2150
12"	DN300	319		2300

螺母可任意选择, 注意“E型”螺母需要加价。

卡箍系列 Clamp series

双销卡箍-A型(推荐型) Double Pin Clamp/A Type(Recommended)

适用于Suitable for: 3A/ISO/IDF/BS/BPE/AS/DIN

代码 Cargo code : F040251

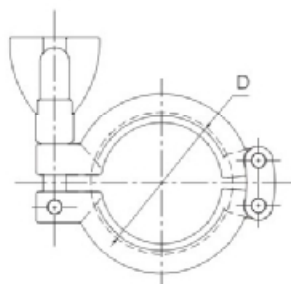

SIZE		卡盘	304
			单重(g)
1"-1.5"	DN25-40	50.5	218
2"	DN50	64	272
2.5"	-	77.5	302
3"	DN65	91	333
3.5"	DN80	106	370
4"	DN100	119	428
4.5"	-	130	446
5"	DN125	145	580
5.5"	DN125	155	775
6"	DN150	166.7	920
6.5"	DN150	183	980
8"	DN200	217	1223
10"	DN250	268	1820
12"	DN300	319	-

螺母可任意选择, 注意“E型”螺母需要加价。

双销卡箍-B型(选型) Double Pin Clamp/B Type(Option)

适用于Suitable for: 3A/ISO/IDF/BS/BPE/AS/DIN

代码 Cargo code : F040252

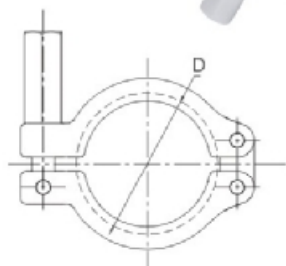

SIZE		卡盘	304
			单重(g)
1"-1.5"	DN25-40	50.5	250
2"	DN50	64	350
2.5"	-	77.5	384
3"	DN65	91	420
3.5"	DN80	106	475
4"	DN100	119	500
4.5"	-	130	640
5"	DN125	145	800
6"	DN150	166.7	1200
6.5"	DN150	183	1290
8"	DN200	217	1550

螺母可任意选择, 注意“E型”螺母需要加价。



双销卡箍-C型(选型) Double Pin Clamp/C Type(Option)

适用于Suitable for: 3A/ISO/IDF/BS/BPE/AS/DIN

代码 Cargo code : F040253



SIZE		卡盘	304
			单重(g)
1'-1.5'	DN25-40	50.5	247
2"	DN50	64	279
2.5"	-	77.5	325
3"	DN65	91	360
3.5"	DN80	106	400
4"	DN100	119	435
4.5"	-	130	452
5"	DN125	145	900
5.5"	DN125	155	1050
6"	DN150	166.7	1125
6.5"	DN150	183	1215
8"	DN200	217	1350
10"	DN250	268	1710
12"	DN300	319	2000

螺母可任意选择, 注意“E型”螺母需要加价。

双销卡箍-D型(选型) Double Pin Clamp/D Type(Option)

适用于Suitable for: 3A/ISO/IDF/BS/BPE/AS/DIN

代码 Cargo code : F040254

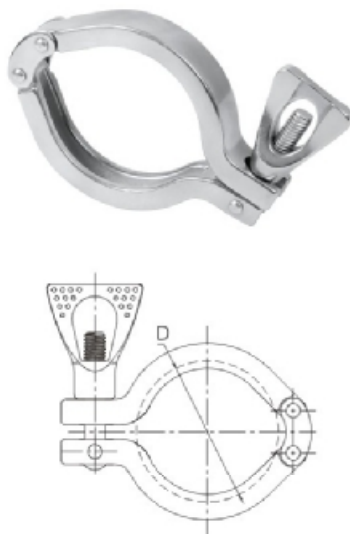

SIZE		卡盘	304
			单重(g)
1'-1.5'	DN25-40	50.5	247
2"	DN50	64	279
2.5"	-	77.5	325
3"	DN65	91	360
3.5"	DN80	106	400
4"	DN100	119	435
4.5"	-	130	452
5"	DN125	145	900
5.5"	DN125	155	1050
6"	DN150	166.7	1125
6.5"	DN150	183	1215
8"	DN200	217	1350
10"	DN250	268	1710
12"	DN300	319	2000

螺母可任意选择, 注意“E型”螺母需要加价。

卡箍系列 Clamp series

高压卡箍-(推荐型) High Pressure Clamp(Recommended)

适用于Suitable for: 3A/ISO/IDF/BS/BPE/AS/DIN

代码 Cargo code : F040261

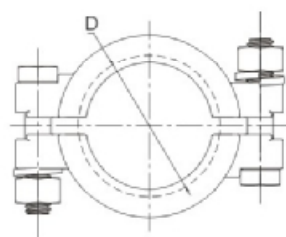

SIZE		卡盘	304
			单重(g)
1/2"-3/4"	DN10-20	25.2	135
1"-1.5"	DN25-40	50.5	355
2"	DN50	64	440
2.5"	-	77.5	490
3"	DN65	91	555
4"	DN100	119	660
5"	DN125	145	1010
6"	DN150	166.7	1090
6.5"	DN150	183	1285
8"	DN200	217	1550
8.5"	-	240	1560
10"	DN250	268	1910
12"	DN300	319	2430

价格已经包含了, 螺母, 螺栓, 垫片。

二片卡箍-(推荐型) 2-pcs Clamp(Recommended)

适用于Suitable for: 3A/ISO/IDF/BS/BPE/AS/DIN

代码 Cargo code : F040262

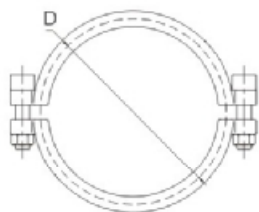

SIZE		卡盘	304
			单重(g)
1"-1.5"	DN25-40	50.5	210
2"	DN50	64	266
2.5"	-	77.5	315
3"	DN65	91	335
3.5"	DN80	106	400
4"	DN100	119	475
4.5"	-	130	570
5"	DN125	145	955
6"	DN150	166.7	990
6.5"	DN150	183	-
8"	DN200	217	1440
10"	DN250	268	2440
11"	-	305	-
12"	DN300	319	2880

价格已经包含了, 螺母, 螺栓, 垫片。



三片卡箍-A型(推荐型) 3-pcs Clamp/A Type(Recommended)

适用于Suitable for: 3A/ISO/IDF/BS/BPE/AS/DIN

代码 Cargo code : F040263

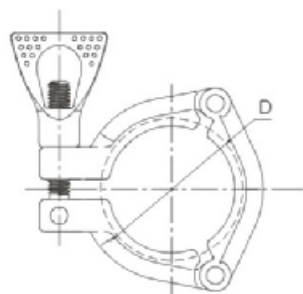

SIZE		卡盘	304
			单重(g)
1"-1.5"	DN25-40	50.5	210
2"	DN50	64	266
2.5"	-	77.5	315
3"	DN65	91	335
3.5"	DN80	106	400
4"	DN100	119	475
4.5"	-	130	570
5"	DN125	145	955
6"	DN150	166.7	990
6.5"	DN150	183	-
8"	DN200	217	1440
10"	DN250	268	2440
11"	-	305	-
12"	DN300	319	2880

螺母可任意选择, 注意“E型”螺母需要加价。

三片卡箍-B型 3-pcs Clamp/B Type

适用于Suitable for: 3A/ISO/IDF/BS/BPE/AS/DIN

代码 Cargo code : F040264

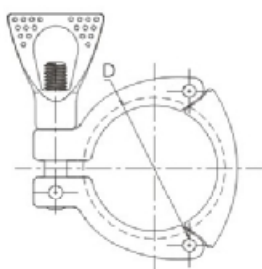

SIZE		卡盘
1"-1.5"	DN25-40	50.5
2"	DN50	64
2.5"	-	77.5
3"	DN65	91
3.5"	DN80	106
4"	DN100	119
4.5"	-	130
5"	DN125	145
6"	DN150	166.7
6.5"	DN150	183
8"	DN200	217
10"	DN250	268
11"	-	305
12"	DN300	319

螺母可任意选择, 注意“E型”螺母需要加价。

卡箍接头 Clamp connector

卡箍接头-A型(微型) Clamp Connector/A Type(MINI)

适用于Suitable for: 3A BS4825-3 AS1528

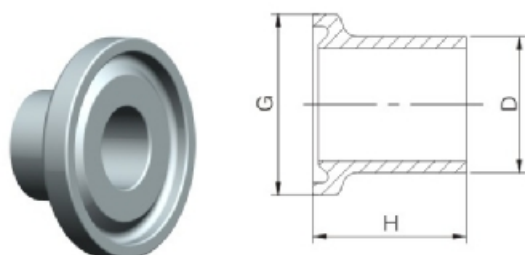

SIZE	尺寸			壁厚
	G	H	D	
货号代码 Cargo code : F040201				
1/2"	25.0	12.7	12.7	1.65
3/4"	25.0	12.7	19.1	1.65
DN6	25.0	12.7	8.0	
DN8	25.0	12.7	10.0	
10.2	25.0	12.7	10.2	1.60
13.5	25.0	12.7	13.5	1.60
17.2	25.0	12.7	17.2	1.60
货号代码 Cargo code : F040202				
1/2"	25.0	21.5	12.7	1.65
3/4"	25.0	21.5	19.1	1.65
货号代码 Cargo code : F040203				
1/2"	25.0	28.6	12.7	1.65
3/4"	25.0	28.6	19.1	1.65
10.2	25.0	28.6	10.2	1.60
13.5	25.0	28.6	13.5	1.60
17.2	25.0	28.6	17.2	1.60



卡箍接头-B型 Clamp Connector/B Type

适用于Suitable for: 3A BS4825-3 AS1528 (14WMP)

货号代码 Cargo code : F040211

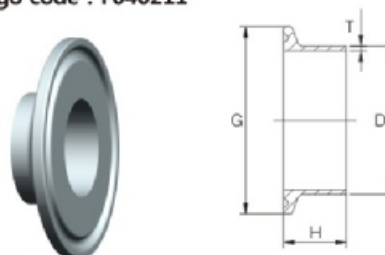

SIZE	尺寸			壁厚T
	G	H	D	
1/2"	50.50	12.70	12.70	1.65
3/4"	50.50	12.70	19.10	1.65
1"	50.50	12.70	25.40	1.65
1.5"	50.50	12.70	38.10	1.65
2"	64.00	12.70	50.80	1.65
2.5"	77.50	12.70	63.50	1.65
3"	91.00	12.70	76.20	1.65
4"	119.00	15.80	101.60	2.10
6"	167.00	22.20	152.40	2.77

卡箍接头-B型 Clamp Connector/B Type

适用于Suitable for: 3A BS4825-3 AS1528(14MMP)

货号代码 Cargo code : F040212

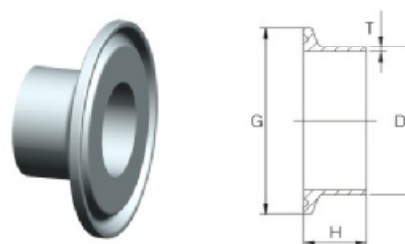

SIZE	尺寸			壁厚
	G	H	D	
1/2"	50.50	21.50	12.70	1.65
3/4"	50.50	21.50	19.10	1.65
1"	50.50	21.50	25.40	1.65
1.5"	50.50	21.50	38.10	1.65
2"	64.00	21.50	50.80	1.65
2.5"	77.50	21.50	63.50	1.65
3"	91.00	21.50	76.20	1.65
4"	119.00	21.50	101.60	2.10
6"	167.00	21.50	152.40	2.77

卡箍接头-B型 Clamp Connector/B Type

适用于Suitable for: 3A BS4825-3 AS1528 (14AMP)

货号代码 Cargo code : F040213

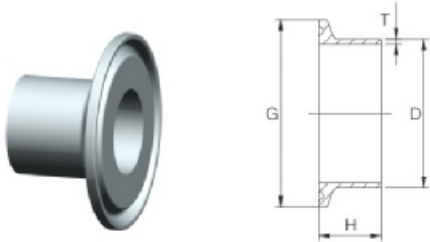

SIZE	尺寸			壁厚
	G	H	D	
1/2"	50.50	28.60	12.70	1.65
3/4"	50.50	28.60	19.10	1.65
1"	50.50	28.60	25.40	1.65
1.5"	50.50	28.60	38.10	1.65
2"	64.00	28.60	50.80	1.65
2.5"	77.50	28.60	63.50	1.65
3"	91.00	28.60	76.20	1.65
4"	119.00	28.60	101.60	2.10
6"	167.00	38.10	152.40	2.77

卡箍接头-B型 Clamp Connector/B Type

适用于Suitable for: ISO2852 SMS 3017

货号代码 Cargo code : F030212

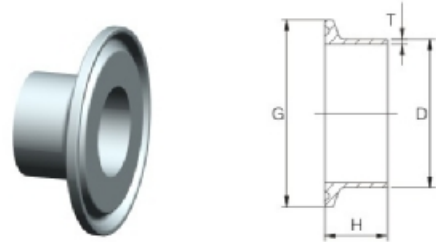

SIZE	尺寸			壁厚	
	G	H	D	推荐	选项
25.4	50.5	21.5	25.4	1.50	1.25
31.8	50.5	21.5	31.8	1.50	1.25
38.1	50.5	21.5	38.1	1.50	1.25
50.8	64.0	21.5	50.8	1.50	1.25
63.5	77.5	21.5	63.5	2.00	1.60
76.2	91.0	21.5	76.2	2.00	1.60
101.6	106.0	21.5	101.6	2.00	2.00

卡箍接头-推荐 Clamp Connector(Recommended)

适用于Suitable for: DIN32676-A (OD=DIN11850; DIN11866-A) -短型 (KK)

货号代码 Cargo code : F020212

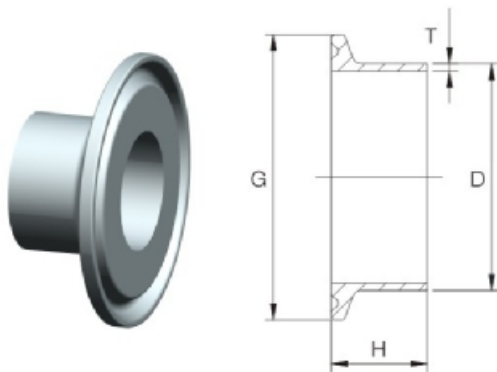

SIZE	尺寸		推荐	二系列	壁厚
	G	H			
DN10	34.0	18.0	12.0	13.0	1.5
DN15	34.0	18.0	18.0	19.0	1.5
DN20	34.0	18.0	22.0	23.0	1.5
DN25	50.5	21.5	28.0	29.0	1.5
DN32	50.5	21.5	34.0	35.0	1.5
DN40	50.5	21.5	40.0	41.0	1.5
DN50	64.0	21.5	52.0	53.0	1.5
DN65	91.0	28.0	70.0	-	2.00
DN80	106.0	28.0	85.0	-	2.00
DN100	119.0	28.0	104.0	-	2.00
DN125	145.0	28.0	129.0	-	2.00
DN125	155.0	28.0	129.0	-	2.00
DN150	167.0	28.0	154.0	-	2.00
DN150	183.0	28.0	154.0	-	2.00
DN200	217.7	28.0	204.0	-	2.00
DN200	233.5	28.0	204.0	-	2.00
DN250	268.0	28.0	254.0	-	2.00
DN300	319.0	28.0	304.0	-	2.00

卡箍接头 Clamp connector

卡箍接头 Clamp Connector

适用于Suitable for: DIN32676-A(OD=DIN11850-2;
DIN11866-A)-长型(KL)

货号代码 Cargo code : F020213

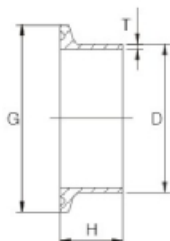

SIZE	尺寸		推荐	二系列	壁厚
	G	H			
DN10	34.0	28.6	12.0	13.0	1.5
DN15	34.0	28.6	18.0	19.0	1.5
DN20	34.0	28.6	22.0	23.0	1.5
DN25	50.5	36.0	28.0	29.0	1.5
DN32	50.5	36.0	34.0	35.0	1.5
DN40	50.5	36.0	40.0	41.0	1.5
DN50	64.0	36.0	52.0	53.0	1.5
DN65	91.0	48.0	70.0	-	2.00
DN80	106.0	48.0	85.0	-	2.00
DN100	119.0	48.0	104.0	-	2.00
DN125	145.0	66.0	129.0	-	2.00
DN125	155.0	66.0	129.0	-	2.00
DN150	167.0	66.0	154.0	-	2.00
DN150	183.0	66.0	154.0	-	2.00
DN200	217.7	66.0	204.0	-	2.00
DN200	233.5	66.0	204.0	-	2.00

卡箍接头 Clamp Connector

适用于Suitable for: DIN 32676-B
(OD=ISO 1127& DIN 11866-B) -短型(KK)

货号代码 Cargo code : F070212

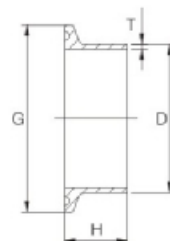

SIZE	尺寸			壁厚
	G	H	D	
21.3	50.5	21.5	21.3	1.60
26.9	50.5	21.5	26.9	2.00
33.7	50.5	21.5	33.7	2.00
42.4	64.0	21.5	42.4	2.00
45.0	64.0	21.5	45.0	2.00
48.3	64.0	21.5	48.3	2.00
57.0	77.5	21.5	57.0	2.00
60.3	77.5	28.0	60.3	2.00
76.1	91.0	28.0	76.1	2.00
88.9	106.0	28.0	88.9	2.30
108.0	119.0	28.0	108.0	2.00
114.3	130.0	28.0	114.3	2.30
133.0	155.0	28.0	133.0	3.00
139.7	155.0	28.0	139.7	2.60
159.0	183.0	28.0	159.0	3.00
168.3	183.0	28.0	168.3	2.60
219.1	233.5	28.0	219.1	2.60



卡箍接头 Clamp Connector

适用于Suitable for: DIN 32676-B
(OD=ISO 1127& DIN 11866-B)-长型(KL)

货号代码 Cargo code : F070213

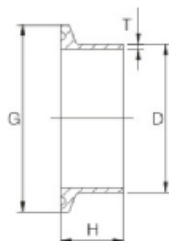

SIZE	尺寸			壁厚
	G	H	D	
21.3	50.5	36	21.3	1.60
26.9	50.5		26.9	2.00
33.7	50.5		33.7	2.00
42.4	64.0		42.4	2.00
45.0	64.0		45.0	2.00
48.3	64.0		48.3	2.00
57.0	77.5		57.0	2.00
60.3	77.5		60.3	2.00
76.1	91.0		76.1	2.00
88.9	106.0		88.9	2.30
108.0	119.0	48	108.0	2.00
114.3	130.0		114.3	2.30
133.0	155.0		133.0	3.00
139.7	155.0		139.7	2.60
159.0	183.0		159.0	3.00
168.3	183.0		168.3	2.60
219.1	233.5		219.1	2.60

卡箍堵头-B型 Clamp Cap/A Type

适用于Suitable for: DIN SMS ISO BS 3A

货号代码 Cargo code : F020232

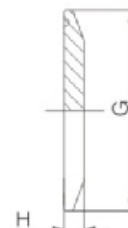

SIZE			卡盘G	长度H
17.2	DN10	-	34.00	6.35
-	DN15	-	34.00	6.35
-	DN20	-	34.00	6.35
21.3	-	-	50.50	6.35
26.9	-	-	50.50	6.35
33.7	DN25	1"	50.50	6.35
-	DN32	1.25"	50.50	6.35
-	DN40	1.5"	50.50	6.35
42.4	DN50	2"	64.00	6.35
45.0	-	-	64.00	6.35
48.3	-	-	64.00	6.35
57.0	-	-	77.50	6.35
60.3	-	2.5"	77.50	6.35
76.1	DN65	3"	91.00	6.35
88.9	DN80	-	106.00	6.35
108.0	DN100	4"	119.00	8.00
114.3	-	-	130.00	8.00
133.0	DN125	-	145.00	14.00
139.7	DN125	-	155.00	14.00
-	DN150	6"	167.00	14.00
159.0	DN150	-	183.00	14.00
168.3	DN200	-	217.70	14.00
219.1	DN200	-	233.50	14.00
-	DN250	-	268.00	14.00
-	DN300	-	319.00	14.00

卡箍堵头-A型 Clamp Cap/B Type

适用于Suitable for: DIN SMS ISO BS 3A

货号代码 Cargo code : F040231

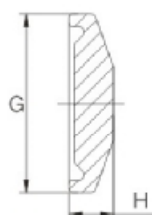

SIZE			卡盘G	长度H
10.2	DN6	1/2"	25.00	6.3
13.5	DN8	3/4"	25.00	6.3

卡箍接头 Clamp connector

膨胀式卡箍接头 Expanded Clamp Connector

适用于Suitable for: 3A BS4825-3 As1528

货号代码 Cargo code : F040214

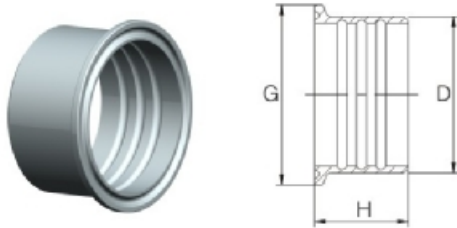

SIZE	尺寸		
	G	H	D
1"	50.50	19.10	29.50
1.5"	50.50	28.60	42.50
2"	64.00	33.30	55.70
2.5"	77.50	34.90	68.80
3"	91.00	36.50	82.00
4"	119.00	38.10	108.00

卡箍垫圈-A型 Clamp Gasket/A Type

适用于Suitable for: DIN SMS ISO BS 3A

货号代码 Cargo code : F040221

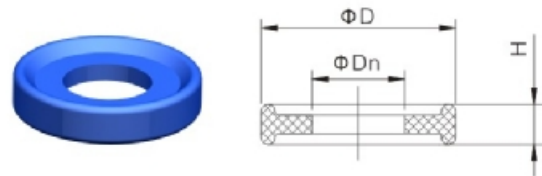

SIZE			D
10.2	DN6	1/2"	21.8
13.5	DN8	3/4"	21.8

卡箍垫圈-B型 Clamp Gasket/B Type

适用于Suitable for: ISO1127

货号代码 Cargo code : F070222

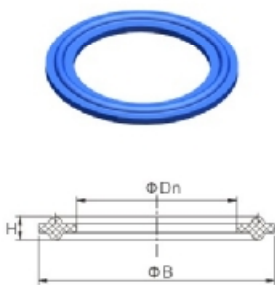

SIZE	卡盘B
17.2	34.00
21.3	50.50
26.9	50.50
33.7	50.50
42.4	64.00
45.0	64.00
48.3	64.00
57.0	77.50
60.3	77.50
76.1	91.00
88.9	106.00
108.0	119.00
114.3	130.00
133.0	145.00
139.7	155.00
159.0	183.00
168.3	217.70
219.1	233.50

卡箍垫圈-B型 Clamp Gasket/B Type

适用于Suitable for: DIN

货号代码 Cargo code : F020222

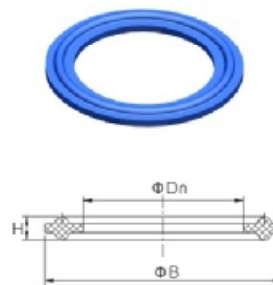

SIZE	卡盘B
DN10	34.00
DN15	34.00
DN20	34.00
DN25	50.50
DN32	50.50
DN40	50.50
DN50	64.00
DN65	91.00
DN80	106.00
DN100	119.00
DN125	145.00
DN125	155.00
DN150	167.00
DN150	183.00
DN200	217.70
DN200	233.50
DN250	268.00
DN300	319.00

卡箍垫圈-B型 Clamp Gasket/B Type

适用于Suitable for: SMS BS 3A ISO

货号代码 Cargo code :
F040222

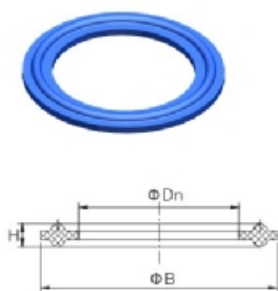

SIZE	卡盘B
1"	50.50
1.25"	50.50
1.5"	50.50
2"	64.00
2.5"	77.50
3"	91.00
4"	119.00
6"	167.00

卡箍垫圈-L型(带翻边) Clamp Gasket/L Type (Lip)

适用于Suitable for: SMS BS 3A ISO

货号代码 Cargo code :
F040223

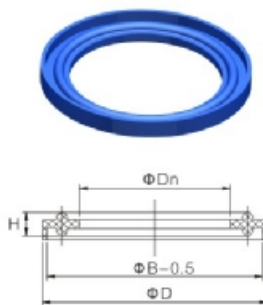

SIZE	卡盘B
1"	50.50
1.25"	50.50
1.5"	50.50
2"	64.00
2.5"	77.50
3"	91.00
4"	119.00
6"	167.00

卡箍垫圈-L型(带翻边) Clamp Gasket/L Type (Lip)

适用于Suitable for: ISO1127

货号代码 Cargo code :
F070223

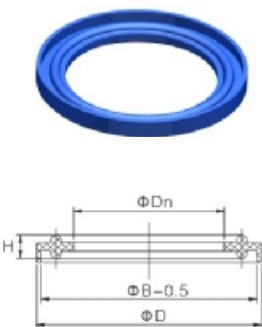

SIZE	卡盘B
17.2	34.00
21.3	50.50
26.9	50.50
33.7	50.50
42.4	64.00
45.0	64.00
48.3	64.00
57.0	77.50
60.3	77.50
76.1	91.00
88.9	106.00
108.0	119.00
114.3	130.00
133.0	145.00
139.7	155.00
159.0	183.00
168.3	217.70
219.1	233.50

卡箍垫圈-L型(带翻边) Clamp Gasket/L Type (Lip)

适用于Suitable for: DIN

货号代码 Cargo code :
F020222

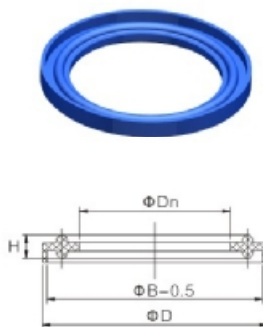

SIZE	卡盘B
DN10	34.00
DN15	34.00
DN20	34.00
DN25	50.50
DN32	50.50
DN40	50.50
DN50	64.00
DN65	91.00
DN80	106.00
DN100	119.00
DN125	145.00
DN125	155.00
DN150	167.00
DN150	183.00
DN200	217.70
DN200	233.50
DN250	268.00
DN300	319.00

I-LINE 卡箍接头

I-LINE Ferrule



I-line 系列卡箍管件是食品、酿酒、油品、水处理等工程较为理想的选择，该系列卡箍管件优势在于压力高，抗震动强，能承受较高温度，拆装简单方便，并且达到卫生要求。

规格：1"-8"

材质：ASTM T304/316L

表面处理：180Grit/300Grit

垫圈可选择：EPDM FPM NBR 常用垫圈Silicon

I-Line Fitting series is a relative ideal option for projects of food, brewing, oils and water-treatment. The advantage is strong resistant vibration and is capable of bearing high pressure and temperature. It is not only easy to both installed and disassembled but also meets hygienic requirements.

Specification: 1"-8"

Material: ASTM T304/316L

Finish: 80Grit/300Grit

Options for Gasket: EPDM FPM NBR Silicon (standard)

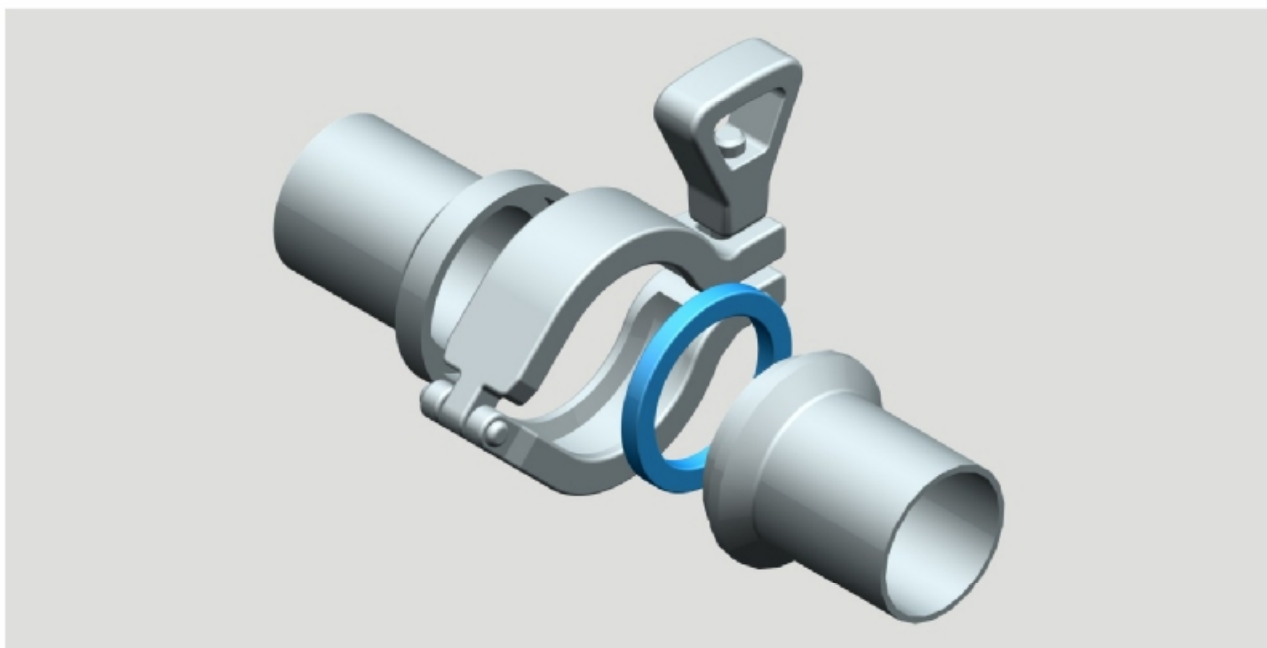

卡箍 Clamp

适用于 Suitable for: I-LINE

货号代码 Cargo code : F100241

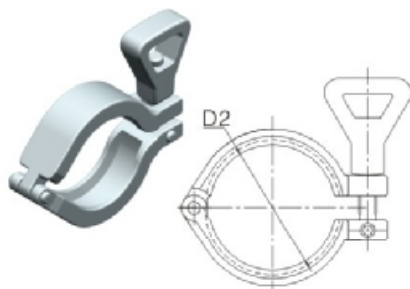

卡箍13IS

SIZE	尺寸 D2
1"-1.5"	50.7
2"	67.1
2.5"	84.0
3"	98.3
4"	123.7
6"	190.5

货号代码 Cargo code : F100242

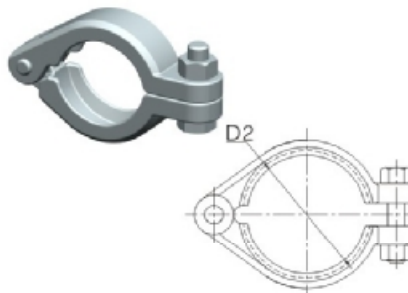

卡箍13I

SIZE	尺寸 D2
1"-1.5"	50.7
2"	67.1
2.5"	84.0
3"	98.3
4"	123.7
6"	190.5

卡箍接头(15WI) Ferrule

适用于Suitable for: I-LINE

货号代码 Cargo code : F100201

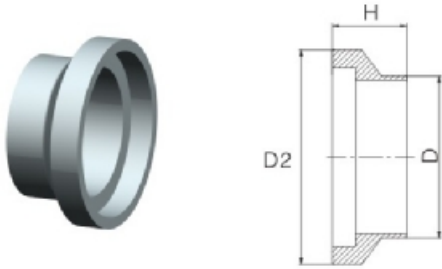

SIZE	尺寸		
	D	D2	H
1"	25.4	50.7	19.8
1.5"	38.1	50.7	23.8
2"	50.8	67.1	26.2
2.5"	63.5	84.0	29.4
3"	76.2	98.3	30.9
4"	101.6	123.7	34.1
6"	152.4	190.5	28.6

卡箍接头(15WLI) Ferrule

适用于Suitable for: I-LINE

货号代码 Cargo code : F100202

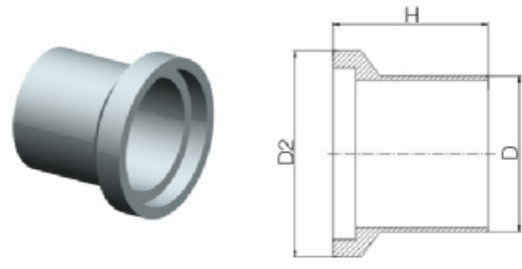

SIZE	尺寸		
	D	D2	H
1"	25.4	50.7	44.4
1.5"	38.1	50.7	51.6
2"	50.8	67.1	58.7
2.5"	63.5	84.0	63.5
3"	76.2	98.3	68.3
4"	101.6	123.7	76.2

卡箍接头(14WI) Ferrule

适用于Suitable for: I-LINE

货号代码 Cargo code : F100211

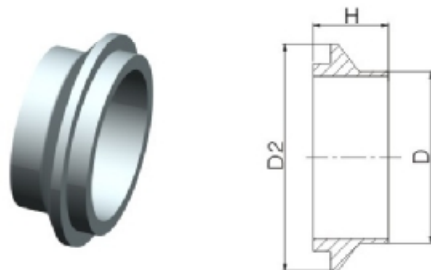

SIZE	尺寸		
	D	D2	H
1"	25.4	50.7	19.8
1.5"	38.1	50.7	23.8
2"	50.8	67.1	26.2
2.5"	63.5	84.0	29.4
3"	76.2	98.3	30.9
4"	101.6	123.7	34.1
6"	152.4	190.5	28.6

卡箍接头(14WLI) Ferrule

适用于Suitable for: I-LINE

货号代码 Cargo code : F100212

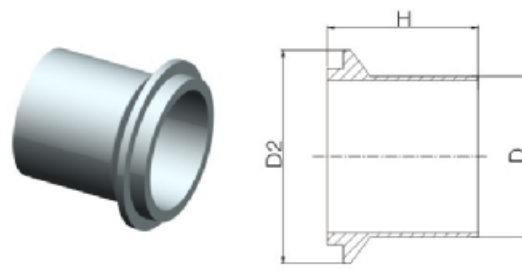

SIZE	尺寸		
	D	D2	H
1"	25.4	50.7	44.4
1.5"	38.1	50.7	51.6
2"	50.8	67.1	58.7
2.5"	63.5	84.0	63.5
3"	76.2	98.3	68.3
4"	101.6	123.7	76.2

I-LINE 卡箍接头

I-LINE Clamp connector

卡箍接头(14WI-CAP) Ferrule

适用于Suitable for: I-LINE

货号代码 Cargo code : F100231

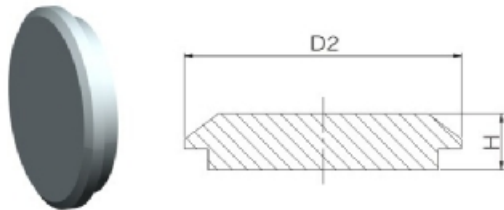

SIZE	尺寸	
	D2	H
1"	50.7	9.7
1.5"	50.7	9.7
2"	67.1	11.8
2.5"	84.0	15.5
3"	98.3	16.1
4"	123.7	16.1

卡箍堵头 (15WI-CAP) Clamp Cap

适用于Suitable for: I-LINE

货号代码 Cargo code : F100232

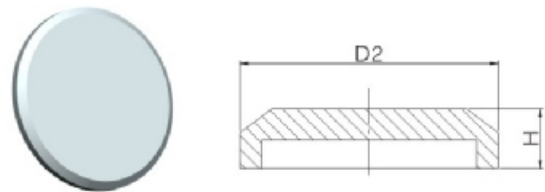

SIZE	尺寸	
	D2	H
1"	50.7	12.8
1.5"	50.7	12.8
2"	67.1	17.7
2.5"	84.0	18.8
3"	98.3	19.4
4"	123.7	19.4

I-LINE垫圈 I-LINE Gasket

适用于Suitable for: I-LINE

货号代码 Cargo code : F100221

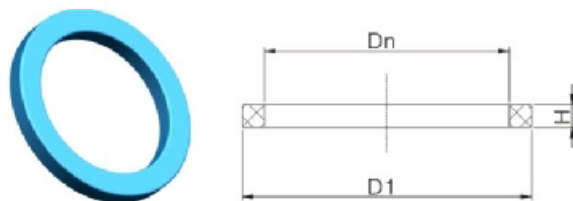

SIZE	尺寸		
	D1	Dn	H
1"	31.8	22.4	2.5
1.5"	44.5	35.1	2.5
2"	57.2	47.8	2.5
2.5"	69.9	60.5	2.5
3"	84.1	73.4	2.5
4"	109.5	97.9	2.5
6"	158.9	147.4	2.5



卡箍/螺纹/对焊, 接头系列

Clamp/ Thread/ Weld Connector Series



单焊接单外螺纹接头-Inch Welded/ Male Adapter - Inch

适用于Suitable for: 3A,AS,BS,SMS,ISO

货号代码 Cargo code : F040801

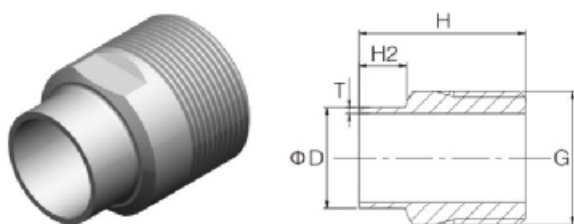

SIZE	尺寸			G (BSP/BSPT /NPT)
	D	H	H2	
0.5"x0.5"	12.7	38	12	1/2"
0.5"x0.75"	12.7	38	12	3/4"
0.75"x0.75"	19	38	12	3/4"
0.5"x1"	12.7	42	12	1"
0.75"x1"	19	42	12	1"
1"x1"	25.4	42	12	1"
0.75"x1.25"	19	44	12	1 1/4"
1"x1.25"	25.4	44	12	1 1/4"
1.25"x1.25"	31.8	44	12	1 1/4"
0.75"x1.5"	19	44	12	1 1/2"
1"x1.5"	25.4	44	12	1 1/2"
1.25"x1.5"	31.8	44	12	1 1/2"
1.5"x1.5"	38.1	44	12	1 1/2"
1"x2"	25.4	46	12	2"
1.25"x2"	31.8	46	12	2"
1.5"x2"	38.1	46	12	2"
2"x2"	50.8	46	12	2"
1"x2.5"	25.4	55	12	2 1/2"
1.5"x2.5"	38.1	55	12	2 1/2"
2"x2.5"	50.8	55	12	2 1/2"
2.5"x2.5"	63.5	55	12	2 1/2"
1"x3"	25.4	55	12	3"
1.5"x3"	38.1	55	12	3"
2"x3"	50.8	55	12	3"
2.5"x3"	63.5	55	12	3"
3"x3"	76.2	55	12	3"
3.5"x3.5"	89	60	15	3 1/2"
4"x4"	101.6	60	15	4"

单焊接单内螺纹接头-Inch Welded/ Female Adapter - Inch

适用于Suitable for: 3A,AS,BS,SMS,ISO

货号代码 Cargo code : F040802

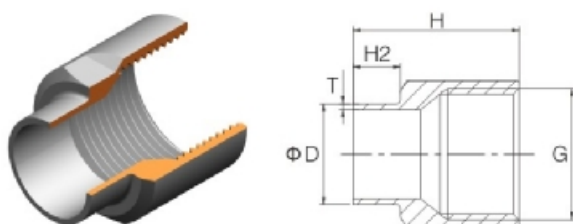

SIZE	尺寸			G (BSP/BSPT /NPT)
	D	H	H2	
0.5"x0.5"	12.7	38	12	1/2"
0.5"x0.75"	12.7	38	12	3/4"
0.75"x0.75"	19	38	12	3/4"
0.5"x1"	12.7	42	12	1"
0.75"x1"	19	42	12	1"
1"x1"	25.4	42	12	1"
0.75"x1.25"	19	44	12	1 1/4"
1"x1.25"	25.4	44	12	1 1/4"
1.25"x1.25"	31.8	44	12	1 1/4"
0.75"x1.5"	19	44	12	1 1/2"
1"x1.5"	25.4	44	12	1 1/2"
1.25"x1.5"	31.8	44	12	1 1/2"
1.5"x1.5"	38.1	44	12	1 1/2"
1"x2"	25.4	46	12	2"
1.25"x2"	31.8	46	12	2"
1.5"x2"	38.1	46	12	2"
2"x2"	50.8	46	12	2"
1"x2.5"	25.4	55	12	2 1/2"
1.5"x2.5"	38.1	55	12	2 1/2"
2"x2.5"	50.8	55	12	2 1/2"
2.5"x2.5"	63.5	55	12	2 1/2"
1"x3"	25.4	55	12	3"
1.5"x3"	38.1	55	12	3"
2"x3"	50.8	55	12	3"
2.5"x3"	63.5	55	12	3"
3"x3"	76.2	55	12	3"
3.5"x3.5"	89	60	15	3 1/2"
4"x4"	101.6	60	15	4"

卡箍/螺纹/对焊, 接头系列

Clamp/ Thread/ Weld Connector Series

单卡箍单外螺纹接头-Inch Clamped / Male Adapter - Inch

适用于Suitable for: 3A,AS,BS,SMS,ISO

货号代码 Cargo code : F040803

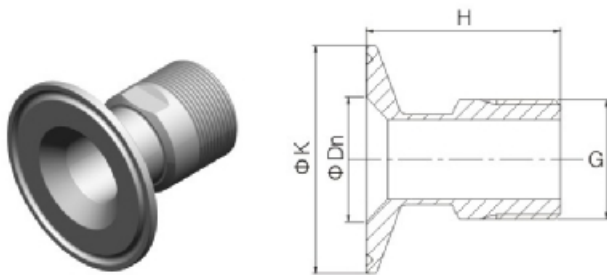

SIZE	尺寸			G (BSP/BSPT /NPT)
	Dn	K	H	
0.5"X0.5"	9.4	25	50.7	1/2"
0.75"X0.5"	15.7	25	50.7	1/2"
0.75"X0.75"	15.7	25	50.7	3/4"
1"X0.5"	22.1	50.5	50.7	1/2"
1"X0.75"	22.1	50.5	50.7	3/4"
1"X1"	22.1	50.5	54.7	1"
1.25"X0.75"	28.8	50.5	50.7	3/4"
1.25"X1"	28.8	50.5	54.7	1"
1.25"X1.25"	28.8	50.5	56.7	1 1/4"
1.5"X0.75"	34.8	50.5	50.7	3/4"
1.5"X1"	34.8	50.5	54.7	1"
1.5"X1.25"	34.8	50.5	56.7	1 1/4"
1.5"X1.5"	34.8	50.5	56.7	1 1/2"
2" X1"	47.5	64	54.7	1"
2" X1.25"	47.5	64	56.7	1 1/4"
2" X1.5"	47.5	64	56.7	1 1/2"
2" X2"	47.5	64	58.7	2"
2.5"X1"	60.2	77.5	54.7	1"
2.5"X1.5"	60.2	77.5	56.7	1 1/2"
2.5"X2"	60.2	77.5	58.7	2"
2.5"X2.5"	60.2	77.5	67.7	2 1/2"
3"X1"	72.9	91	54.7	1"
3"X1.5"	72.9	91	56.7	1 1/2"
3"X2"	72.9	91	58.7	2"
3"X2.5"	72.9	91	67.7	2 1/2"
3"X3"	72.9	91	67.7	3"
4"X4"	97.4	119	75.8	4"

单卡箍单内螺纹接头-Inch Clamped /Female Adapter - Inch

适用于Suitable for: 3A,AS,BS,SMS,ISO

货号代码 Cargo code : F040804

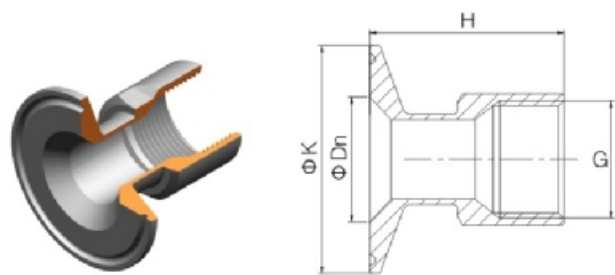

SIZE	尺寸			G (BSP/BSPT /NPT)
	Dn	K	H	
0.5"X0.5"	9.4	25	50.7	1/2"
0.75"X0.5"	15.7	25	50.7	1/2"
0.75"X0.75"	15.7	25	50.7	3/4"
1"X0.5"	22.1	50.5	50.7	1/2"
1"X0.75"	22.1	50.5	50.7	3/4"
1"X1"	22.1	50.5	54.7	1"
1.25"X0.75"	28.8	50.5	50.7	3/4"
1.25"X1"	28.8	50.5	54.7	1"
1.25"X1.25"	28.8	50.5	56.7	1 1/4"
1.5"X0.75"	34.8	50.5	50.7	3/4"
1.5"X1"	34.8	50.5	54.7	1"
1.5"X1.25"	34.8	50.5	56.7	1 1/4"
1.5"X1.5"	34.8	50.5	56.7	1 1/2"
2" X1"	47.5	64	54.7	1"
2" X1.25"	47.5	64	56.7	1 1/4"
2" X1.5"	47.5	64	56.7	1 1/2"
2" X2"	47.5	64	58.7	2"
2.5"X1"	60.2	77.5	54.7	1"
2.5"X1.5"	60.2	77.5	56.7	1 1/2"
2.5"X2"	60.2	77.5	58.7	2"
2.5"X2.5"	60.2	77.5	67.7	2 1/2"
3"X1"	72.9	91	54.7	1"
3"X1.5"	72.9	91	56.7	1 1/2"
3"X2"	72.9	91	58.7	2"
3"X2.5"	72.9	91	67.7	2 1/2"
3"X3"	72.9	91	67.7	3"
4"X4"	97.4	119	75.8	4"

卡压式软管接头 Jam-on hose coupler

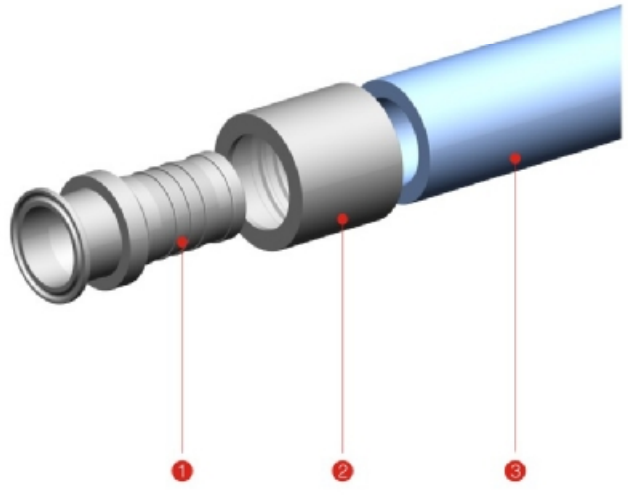
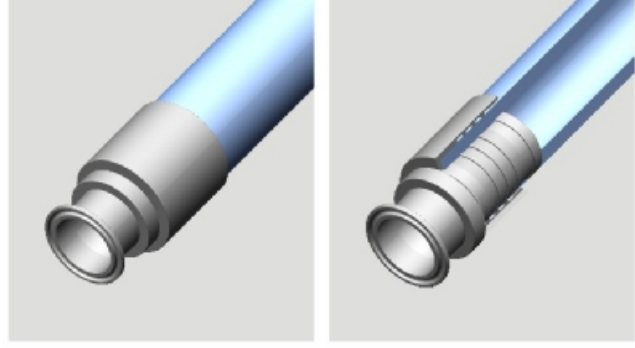

货号代码 Code : F040512

货号代码 Code : F040515



货号代码 Cargo code : F040513



编号 No.	名称 Product name	材质 Material	材质 Material
1#	卡箱式卡压型软管接头 Clamped Jam-on Hose Coupler	316L	304
2#	卡压式软管接头-外套管 Outer Sleeve for Jam-on Coupler	316L	304
3#	软管 Hose		

注意：卡压型软管接头，需使用软管接头与外套管配套使用
Note: Hose coupler needs be matched with outer sleeve.



卡压式软管接头 Jam-on hose coupler

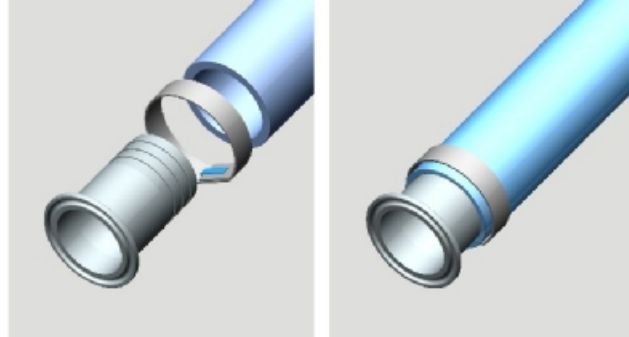

焊接式软管接头-Inch Weld hose coupler -Inch

适用于Suitable for: 3A, AS, BS, SMS, ISO

货号代码 Cargo code : F010501

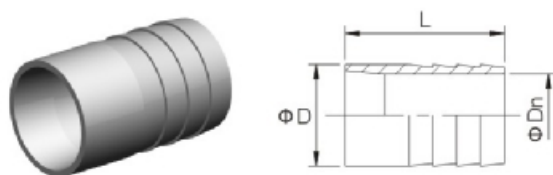

SIZE	尺寸		
	D	Dn	L
1/4"	10	5	30
3/8"	11	6.2	30
1/2"	13.7	9.5	30
3/4"	21.4	15.8	30
1"	25.4	20.6	40
1 1/4"	31.8	26.8	40
1 1/2"	38.1	33.2	40
2"	50.8	46	50
2 1/2"	63.5	58.7	50
3"	76.2	70	70
4"	101.6	96	80

异径卡箍式软管接头-Inch Eccentric Clamp Hose Coupler -Inch

适用于Suitable for: 3A, AS, BS, SMS, ISO

货号代码 Cargo code : F010502

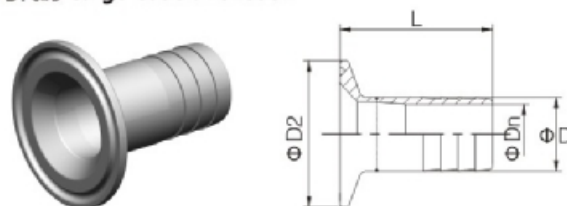

SIZE	尺寸				
	D	Dn	L	D2	D3
1.5"X0.5"	13.7	9.5	42.7	50.5	35.1
1.5"X0.75"	21.4	15.8	42.7	50.5	35.1
1.5"X1"	25.4	20.6	52.7	50.5	35.1
2"X0.5"	13.7	9.5	42.7	64	47.8
2"X0.75"	21.4	15.8	42.7	64	47.8
2"X1"	25.4	20.6	52.7	64	47.8
2"X1.5"	38.1	33.2	52.7	64	47.8

焊接式软管接头-DIN Weld hose coupler -DIN

适用于Suitable for: DIN

货号代码 Cargo code : F020501

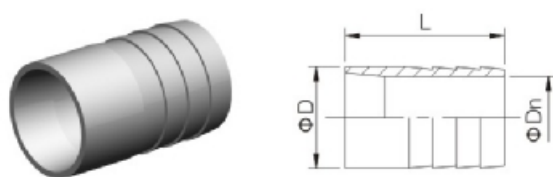

SIZE	尺寸		
	D	Dn	L
DN15	18	14	30
DN20	22	18	40
DN25	28	24	40
DN32	34	30	40
DN40	40	35	40
DN50	52	47	50
DN65	70	64	70
DN80	85	79	70
DN100	104	98	80

卡箍式软管接头-Inch Clamp Hose Coupler -Inch

适用于Suitable for: 3A, AS, BS, SMS, ISO

货号代码 Cargo code : F010503

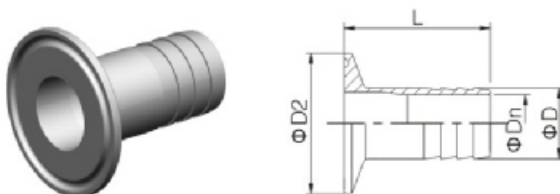

SIZE	尺寸			
	D	Dn	L	D2
1/4"	10	5	42.7	25.4
3/8"	11	6.2	42.7	25.4
1/2"	13.7	9.5	42.7	25.4
3/4"	21.4	15.8	42.7	25.4
1"	25.4	20.6	52.7	50.5
1 1/4"	31.8	26.8	52.7	50.5
1 1/2"	38.1	33.2	52.7	50.5
2"	50.8	46	62.7	64
2 1/2"	63.5	58.7	62.7	77.5
3"	76.2	70	82.7	91
4"	101.6	96	95.8	119

卡箍式软管接头-DIN
Clamp Hose Coupler -DIN

适用于Suitable for: DIN

货号代码 Cargo code : F020503

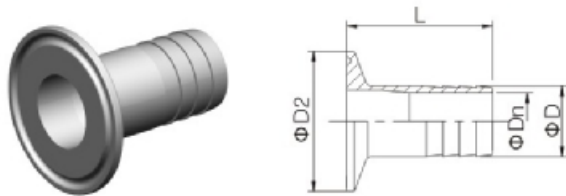

SIZE	尺寸			
	D	Dn	L	D2
DN20	22	18	58	34
DN25	28	24	61.5	50.5
DN32	34	30	61.5	50.5
DN40	40	35	61.5	50.5
DN50	52	47	71.5	64
DN65	70	64	98	91
DN80	85	79	98	106
DN100	104	98	108	119

螺母式软管接头-DIN
Nut Hose Coupler -DIN

适用于Suitable for: DIN

货号代码 Cargo code : F020505

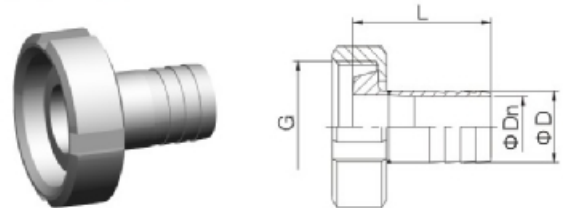

SIZE	尺寸			
	D	Dn	L	G
DN25	28	24	54	Rd52X1/6
DN32	34	30	54	Rd58X1/6
DN40	40	35	56	Rd65X1/6
DN50	52	47	67	Rd78X1/6
DN65	70	64	88	Rd95X1/6
DN80	85	79	90	Rd110X1/4
DN100	104	98	102	Rd130X1/4

螺纹式软管接头-DIN
Thread Hose Coupler -IDF

适用于Suitable for: DIN

货号代码 Cargo code : F020506

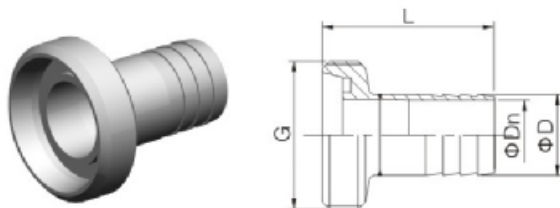

SIZE	尺寸			
	D	Dn	L	G
DN25	28	24	60	Rd52X1/6
DN32	34	30	60	Rd58X1/6
DN40	40	35	60	Rd65X1/6
DN50	52	47	71	Rd78X1/6
DN65	70	64	93	Rd95X1/6
DN80	85	79	95	Rd110X1/4
DN100	104	98	108	Rd130X1/4

螺母式软管接头-SMS
Nut Hose Coupler -SMS

适用于Suitable for: SMS

货号代码 Cargo code : F030505

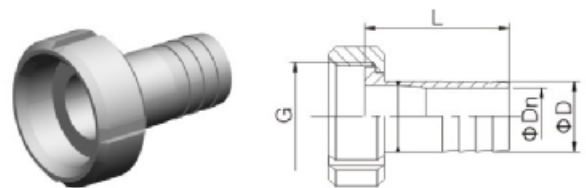

SIZE	尺寸			
	D	Dn	L	G
25	25.4	20.6	52	Rd40X1/6
32	31.8	26.8	52	Rd48X1/6
38	38.1	33.2	53	Rd60X1/6
51	50.8	46	63	Rd70X1/6
63	63.5	58.7	64	Rd85X1/6
76	76.2	70	84	Rd98X1/6
102	101.6	96	97	Rd132X1/6

卡压式软管接头 Jam-on hose coupler

螺纹式软管接头-SMS Thread Hose Coupler -SMS

适用于Suitable for: SMS

货号代码 Cargo code : F030506

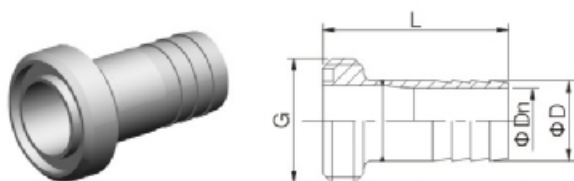

SIZE	尺寸			
	D	Dn	L	G
25	25.4	20.6	59	Rd40X1/6
32	31.8	26.8	58	Rd48X1/6
38	38.1	33.2	60	Rd60X1/6
51	50.8	46	70	Rd70X1/6
63	63.5	58.7	74	Rd85X1/6
76	76.2	70	95	Rd96X1/6
102	101.6	96	107	Rd132X1/6

螺母式软管接头-3A Nut Hose Coupler -3A

适用于Suitable for: 3A

货号代码 Cargo code : F040505

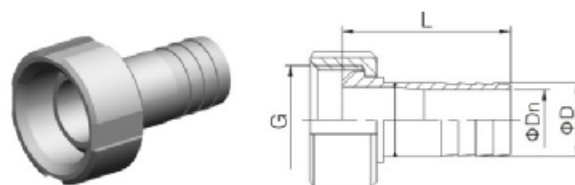

SIZE	尺寸			
	D	Dn	L	G(ACME)
1"	25.4	20.6	58.3	38.02X1/8
1.5"	38.1	33.2	58.3	51.54X1/8
2"	50.8	46	69.1	65.05X1/8
2.5"	63.5	58.7	72.3	78.56X1/8
3"	76.2	70	93.1	92.08X1/8
4"	101.6	96	106.2	120.14X1/6

螺纹式软管接头-3A Thread Hose Coupler -3A

适用于Suitable for: 3A

货号代码 Cargo code : F040506

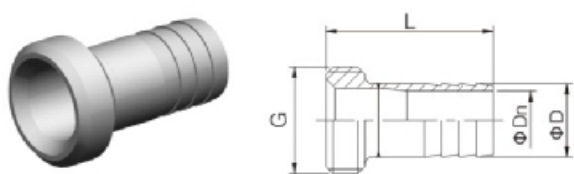

SIZE	尺寸			
	D	Dn	L	G(ACME)
1"	25.4	20.6	58.3	38.02X1/8
1.5"	38.1	33.2	58.3	51.54X1/8
2"	50.8	46	69.1	65.05X1/8
2.5"	63.5	58.7	72.3	78.56X1/8
3"	76.2	70	93.1	92.08X1/8
4"	101.6	96	106.2	120.14X1/6

螺母式软管接头-ISO/IDF Nut Hose Coupler -ISO/IDF

适用于Suitable for: ISO/IDF

货号代码 Cargo code : F050505

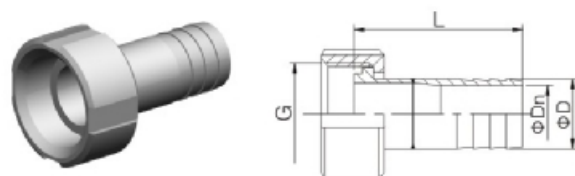

SIZE	尺寸			
	D	Dn	L	G(ACME)
1"	25.4	20.6	61.5	38.3X1/8
1.5"	38.1	33.2	61.5	51.8X1/8
2"	50.8	46	71.5	65.3X1/8
2.5"	63.5	58.7	71.5	78.8X1/8
3"	76.2	70	91.5	92.3X1/8
4"(IDF)	101.6	96	110	127.2X1/6
4"(ISO)	101.6	96	101.5	119.4X1/8

螺纹式软管接头-ISO/IDF
Thread Hose Coupler -ISO/IDF

适用于Suitable for: ISO/IDF

货号代码 Cargo code : F050506

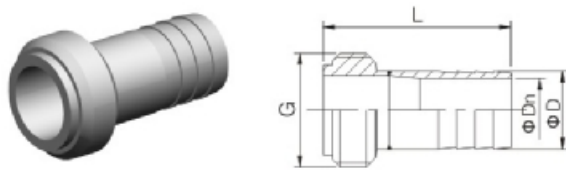

SIZE	尺寸			
	D	Dn	L	G(ACME)
1"	25.4	20.6	61.5	37.13X1/8
1.5"	38.1	33.2	61.5	50.65X1/8
2"	50.8	46	71.5	64.16X1/8
2.5"	63.5	58.7	71.5	77.7X1/8
3"	76.2	70	91.5	91.2X1/8
4"(IDF)	101.6	96	110	125.9X1/6
4"(ISO)	101.6	96	101.5	118.4X1/8

螺母式软管接头-RJT
Nut Hose Coupler -RJT

适用于Suitable for: RJT

货号代码 Cargo code : F110505

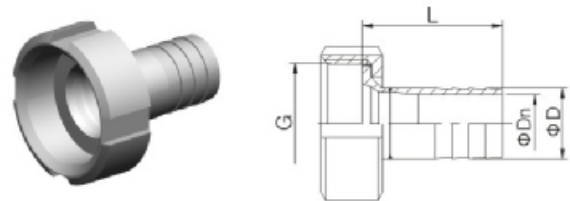

SIZE	尺寸			
	D	Dn	L	G(WHIT)
1"	25.4	20.6	50	45.7X1/8
1.5"	38.1	33.2	50	58.4X1/8
2"	50.8	46	60	72.7X1/6
2.5"	63.5	58.7	60	85.4X1/6
3"	76.2	70	80	98.1X1/6
4"	101.6	96	92.7	123.8X1/6

螺纹式软管接头-RJT
Thread Hose Coupler -RJT

适用于Suitable for: RJT

货号代码 Cargo code : F110505

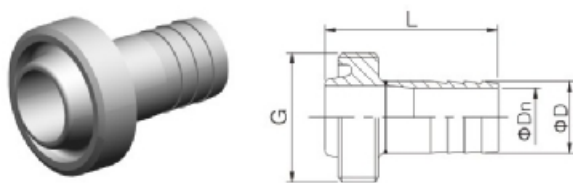

SIZE	尺寸			
	D	Dn	L	G(WHIT)
1"	25.4	20.6	67	45.7X1/8
1.5"	38.1	33.2	67	58.4X1/8
2"	50.8	46	77	72.7X1/6
2.5"	63.5	58.7	77	85.4X1/6
3"	76.2	70	97	98.1X1/6
4"	101.6	96	107	123.8X1/6





CHINA DONJOY TECHNOLOGY CO.,LTD.

DONJOY looking forward to your visit! Your telecommunications!



中国·东正 科技有限公司

温州空港新区：
温州通海大道港富路25号
总机：0577-86990888
传真：0577-86998000

Wenzhou airport Area:
No.25 Gangfu Road,Tonghai Avenue,
wenzhou
Tel: +86-577-86990888
Fax: +86-577-86998000
E-mail: donjoy@cndonjoy.com

www.cndonjoy.com

法律声明：

目录样册版本属东正所有，如有抄袭东正将追究其法律责任和经济赔偿。东正已获得国家版权局书刊号。东正众多技术设计，都具有专利保护，如有抄袭，东正必将追究法律责任和经济赔偿。